

Nereide 2

SCP-210 and SPU-303 manual

document v1.4

Content:

1	Introduction.....	3
1.1	Product description.....	3
1.2	Glossary of terminology.....	3
2	Connecting the control panel.....	4
2.1	Power source and power modes.....	4
2.2	Simarine devices.....	5
2.3	Sensors.....	5
2.4	Connecting and switching a bilge pump.....	7
2.5	Bilge pump status indicator.....	8
2.6	Connecting and switching remote switches.....	9
2.7	Connectors – detailed description.....	12
3	CAN and NMEA ports.....	13
3.1	Basic description and connecting.....	13
3.2	NMEA2000 data streaming.....	13
3.3	NMEA2000 remote switching.....	14
4	DC distribution unit.....	15
4.1	Table of connector pins and corresponding fuses.....	16
5	Using the control panel and distribution units.....	19
5.1	Button illumination and errors.....	19
5.2	Manual switching of relays on the distribution unit.....	20
6	Predefined configurations.....	21
6.1	Sailboat small configuration.....	21
6.2	Sailboat big configuration.....	22
6.3	Motorboat configuration.....	22
7	Dimensions and mounting details.....	23
7.1	SCP-210 dimensions.....	23
7.2	SCP-210 cut-out template.....	24
7.3	SPU-303 dimensions.....	25
8	Change notes.....	26

1 Introduction

1.1 Product description

SCP-210 control panel and SPU-303 DC distribution unit are Simarine products used for switching of low voltage DC consumers and devices. The panel and unit are used in conjunction. The buttons on the control panel control the states of the relays on the distribution unit.



Figure 1: Control panel SCP-210

1.2 Glossary of terminology

Nereide 2	Control panel with switches and integrated PICO battery monitor. Simarine product label SCP-210.
SiCAN	Proprietary CAN-bus based protocol for connecting distribution units to control panels.
SiCOM	Proprietary RS485 based protocol for connecting Simarine units to PICO.
MFD	Multi-functional display.
NMEA2000	Protocol for connecting and communicating between marine oriented devices.
N2k	Abbreviation for NMEA2000.

Table 1: List of terminology.

2 Connecting the control panel

The control panel allows connection of up to 8 resistance sensors and 7 voltage sensors. It is also compatible with all other Simarine devices.

2.1 Power source and power modes

The panel requires 12 V DC voltage source protected with a 2 A fuse. Maximum ratings for the power supply voltage source are:

- min.: 6 V DC
- max.: 35 V DC

The recommended source of power:

- control panel: 12 V DC from battery, either directly or through a main switch

Current ratings for typical system (single SCP-210 control panel with 1 SPU-303 distribution unit):

- Normal operation mode: 100 – 200 mA
- Low power with bilge LED active: 50 mA
- Low power with bilge LED inactive: 40 mA

“Normal mode” is the state when the control panel is turned on. All buttons are active and the user can operate the consumers by pressing the buttons. PICO battery monitor is active and fully functional.

“Low power mode” is a low power state when the user turns off the control panel by long pressing the power button. In this state the buttons are disabled. If the control panel is configured to use the integrated bilge pump functionality, the bilge pump LED indicator will be active for 24 hours. PICO battery monitor enters sleep state, monitoring is active, but the user cannot interface with the device.

The control panel may be configured to enable or disable the low power mode. With the low power mode ENABLED, the device will enter low power mode when the user turns off (long hold of power button) the panel. With the low power mode DISABLED, the control panel will fully turn off when the user turns off the panel. This means that also PICO battery monitor will be fully turned off.

The low power mode can be enabled/disabled by toggling the switch behind the back cover (the cover has to be removed by undoing the bolts) as is pictured below.

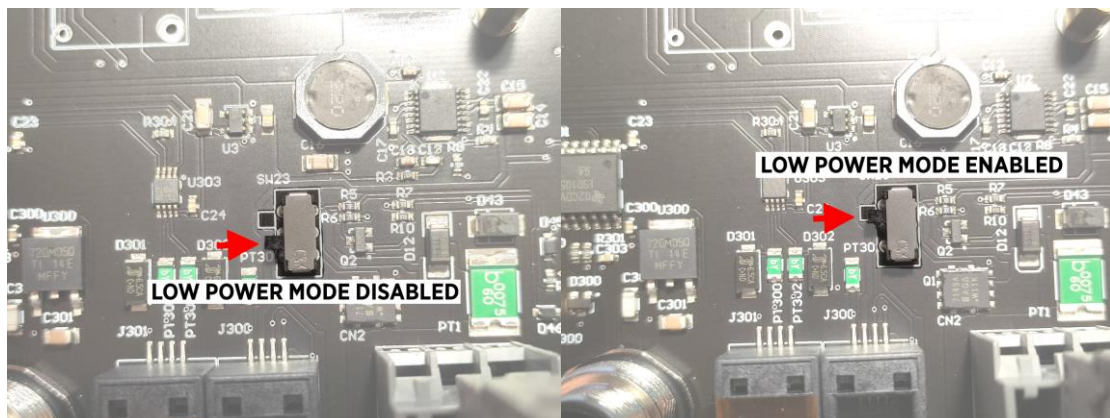

Figure 2: Low power mode enable/disable switch.

2.2 Simarine devices

The panel supports all other Simarine devices. It connects to them through SiCOM. The devices can connect directly to the 2 SiCOM ports. The panel itself provides the power to the SiCOM ports. Using a SiCOM splitter is not permitted. See figure 2 for more information.

2.3 Sensors

As previously stated, the control panel SCP-210 has 8 resistance measuring inputs and 7 voltage inputs.

Ohmmeter specification:

- 8 inputs
- range: 0 – 65 k Ω
- resolution: 1 Ω
- precision: $\pm 3\%$

Voltmeter specification:

- 7 inputs
- range: 0 – 70 V DC
- resolution: 1 mV
- precision: $\pm 1\%$

All inputs are shown on the integrated PICO and can be configured as any other sensor. See PICO manual for more information.

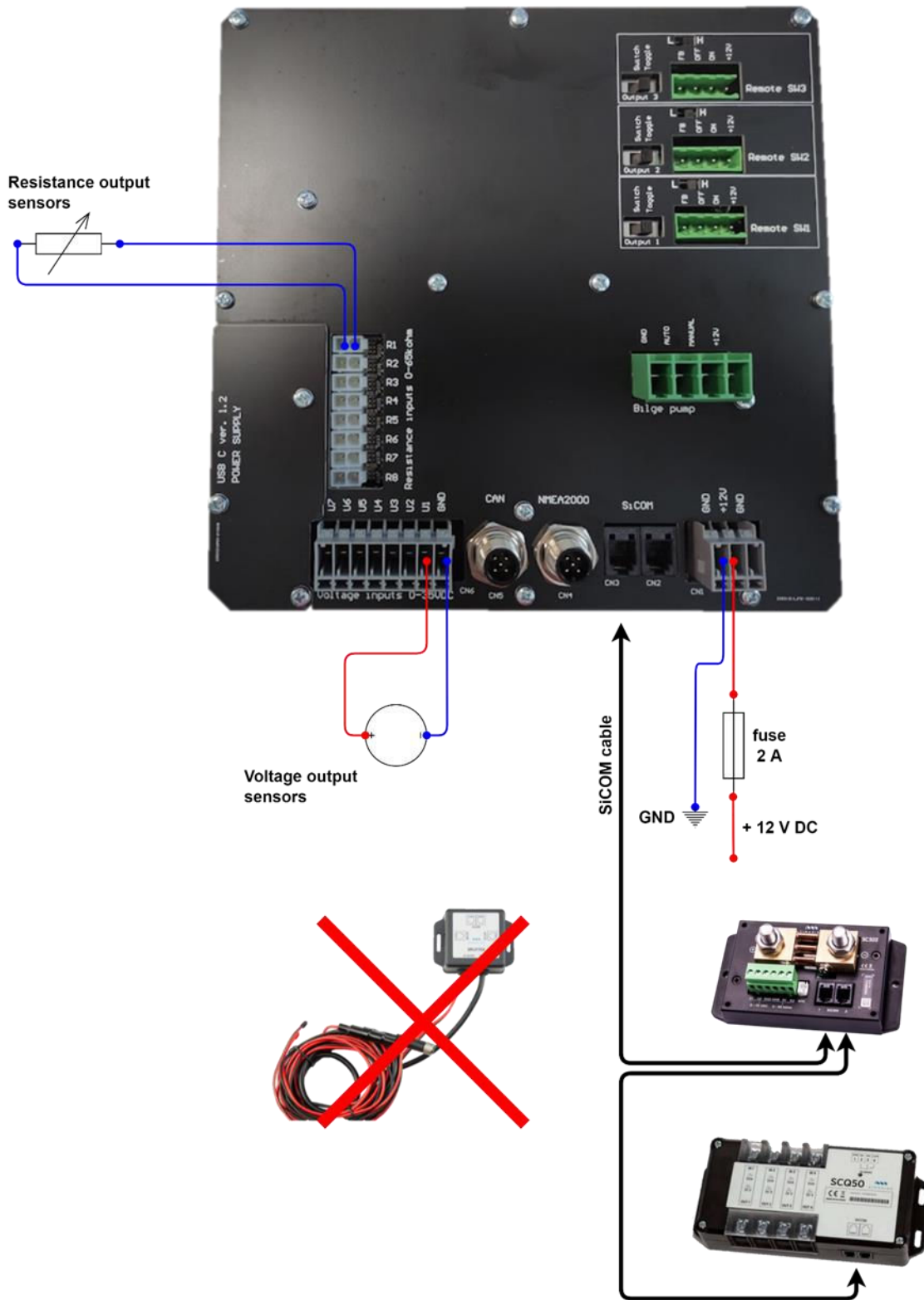

Figure 3: Control panel connections diagram.

2.4 Connecting and switching a bilge pump

Note: This function is only available per request when ordering the Nereide 2 system!

A bilge pump can be connected to the control panel. The recommended wiring schematics is shown on the figure below. The +12V pin is an input for the battery voltage, and the MANUAL and AUTO pins are outputs. The AUTO pin should be connected to the floater switch and the MANUAL pin directly to the bilge pump motor.

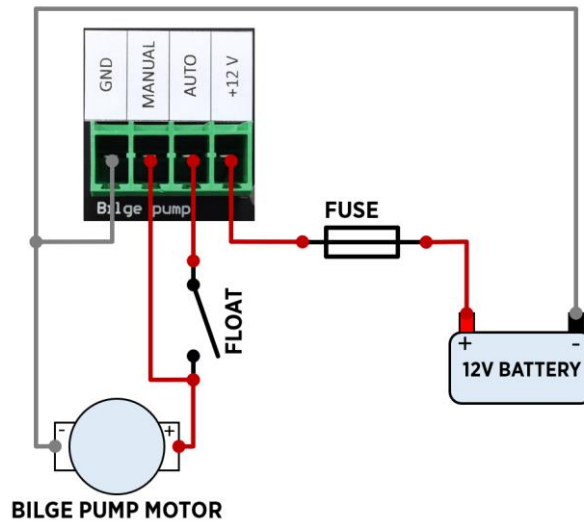

Figure 4: Connecting a bilge pump.

When pressing the dedicated BILGE PUMP button on the front of the control panel the integrated relay will enable the output on the MANUAL pin. The AUTO pin output is always enabled, unless the dedicated button is pressed. The switching is done by an internal relay for which schematics is provided below.

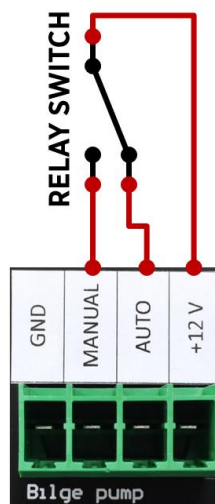

Figure 5: Internal schematics of the bilge pump connector.

2.5 Bilge pump status indicator

There is also a feedback system implemented for alerting the user the status of the bilge pump connections. The status is indicated by the dedicated button showing different colours and/or flashing. The control panel monitors the input voltage on the +12V pin and the voltage on the MANUAL pin. By monitoring these two pins the control panel can determine when the bilge pump has been turned on by the floater switch or any possible error states. The descriptions are provided below.





	Constant green	Normal operation, voltage on +12V detected, bilge pump not operating.
	Constant blue	The button is pressed, and the bilge pump is operating.
	Flashing green/blue	Normal operation, voltage on +12V detected, floater switch turned ON, bilge pump operating.
	Flashing blue/red	Error state! Button pressed, voltage on MANUAL pin not detected. Control panel relay problem. Bilge pump might not be operating!
	Constant red	Error state! Input voltage on +12V pin not detected. Check for blown fuse, connection to the battery or wiring issues. Bilge pump might not be operating!

Table 2: Bilge pump status descriptions.

2.6 Connecting and switching remote switches

Note: This function is only available per request when ordering the Nereide 2 system!

Up to three remote switches can be connected to the control panel. Supported remote switches can have two types of signals for controlling. A “TOGGLE” and “SWITCH” type.

The TOGGLE type has two wires for control. A pulse on one wire closes the remote switch and a pulse on the other closes it. An example of wiring for this type is shown on Figure 8: Toggle signal type of remote switch.

The SWITCH type has only one wire for controlling. If this wire has 12 V DC voltage present, the remote switch closes and if it has no voltage or is connected to ground it opens. These two types are applicable to most remote switches available on the marine market. An example is shown on Figure 9: Switch signal type of remote switch.

The type of remote switch is selected with the switch marked on the figure below:



Figure 6: Selecting the type of remote switch.

The control panel also has capability to detect the current state of the remote switch. This is done by connecting the feedback signal to the FB pin on the connector. With the switch marked on the figure below you can select the level of the feedback signal.

Selecting “L” is for a feedback signal that is driven low (connected to ground) when the remote switch is closed. This is common on remote switches that have a LED OUTPUT instead of FEEDBACK OUTPUT.

Selecting “H” is for a feedback signal that is driven high (12V DC) when the remote switch closes. This can also be used in cases when the remote switch does not have a feedback output or when the output does not have compatible signals. In this case it is possible to wire the feedback signal from the consumer side of the remote switch main contacts as seen on Figure 10: Feedback signal from remote switch output. **If this type of wiring is used it is important to use a fuse. The fuse can be rated for as little as 100mA or less. Fuses with larger ratings should be avoided.**



Figure 7: selecting the level of feedback signal.

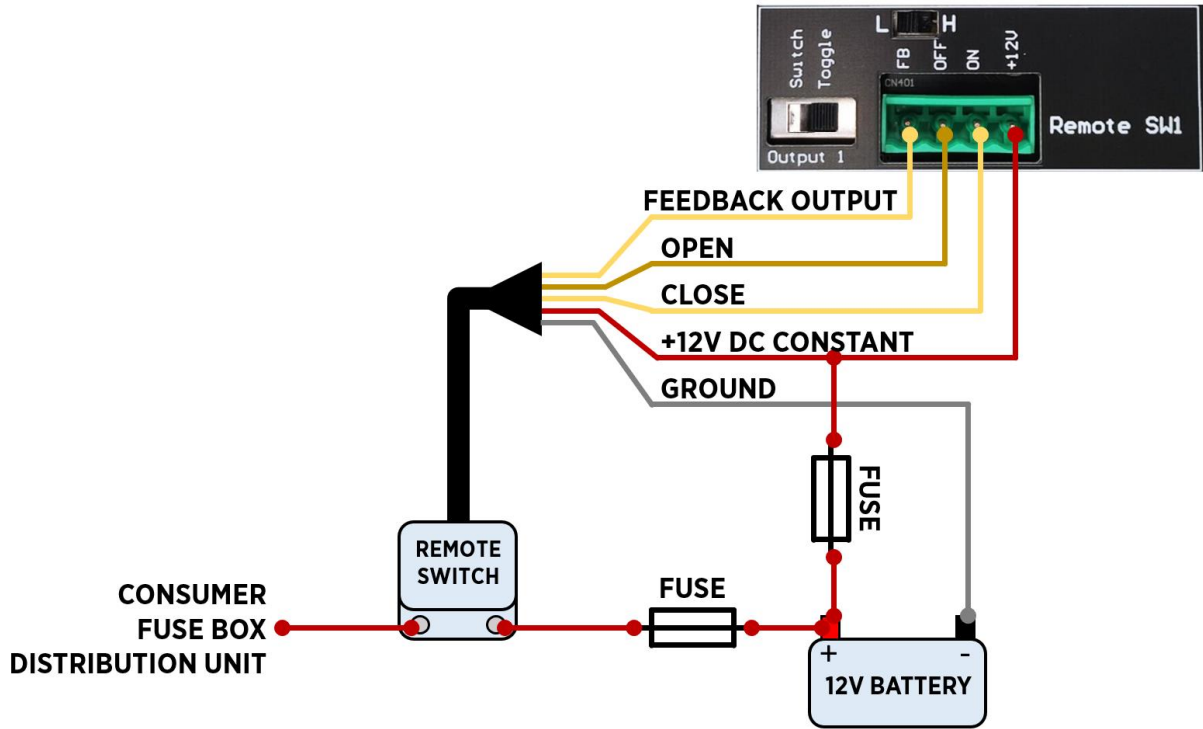

Figure 8: Toggle signal type of remote switch.

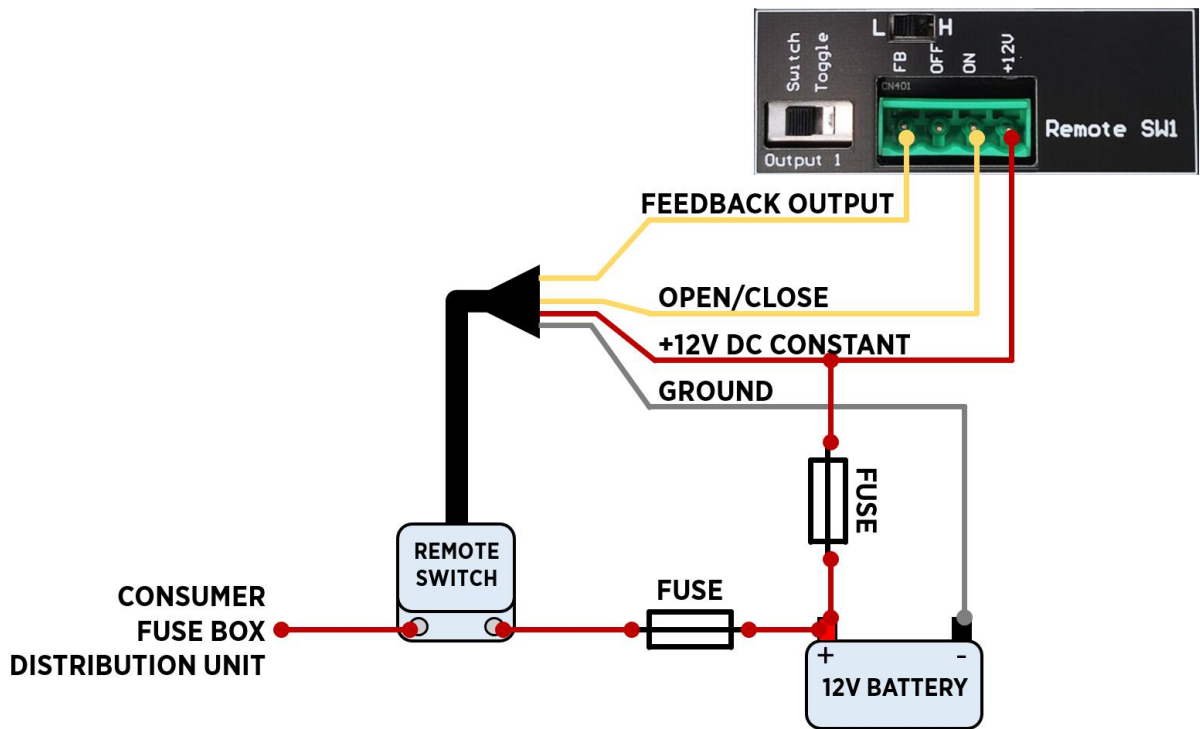

Figure 9: Switch signal type of remote switch.

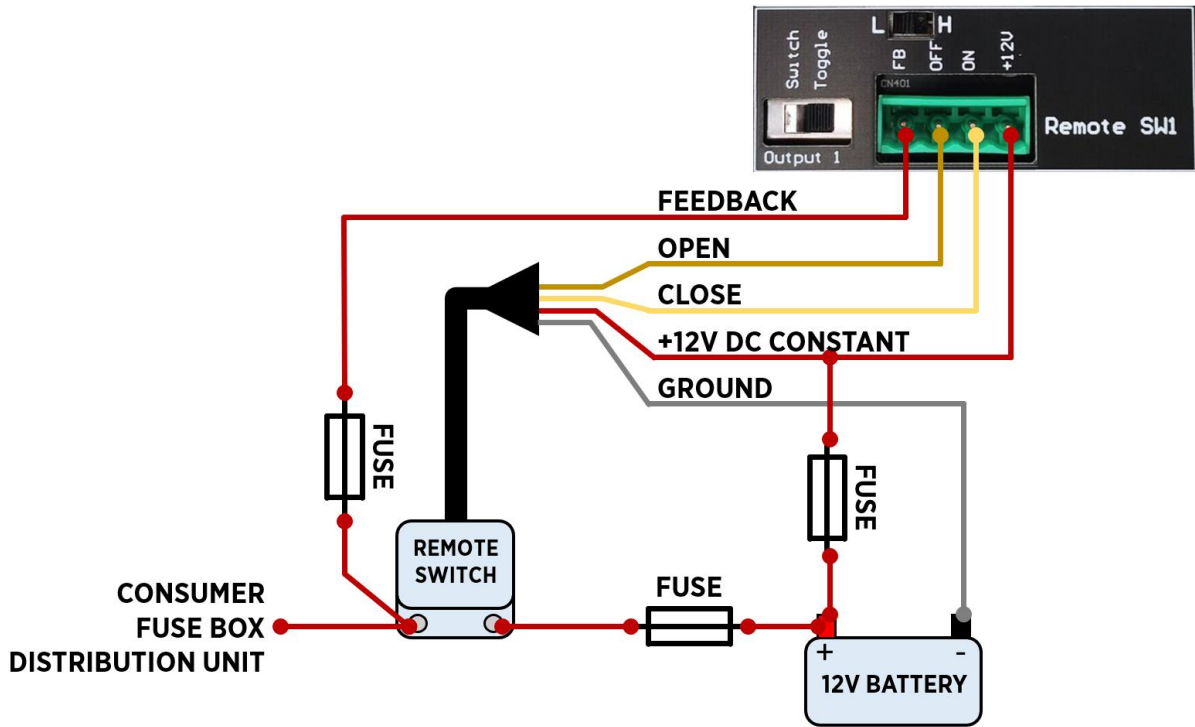

Figure 10: Feedback signal from remote switch output.

Remote switch connector pin descriptions:

+12V	Input	Voltage source input, 12V DC from battery, protected by a fuse (recommended 1A or lookup into remote switch datasheet).
OFF	Output	If selected "SWITCH" type: constantly outputs 12V when the dedicated button is turned OFF. If selected "TOGGLE" type: outputs a short pulse (100 ms) when the dedicated button turns to OFF.
ON	Output	If selected "SWITCH" type: constantly outputs 12V when the dedicated button is turned ON. If selected "TOGGLE" type: outputs a short pulse (100 ms) when the dedicated button turns to ON.
FB	Input	Feedback input. Allowed voltage range 0 – 15V DC. Connected to feedback or LED outputs of remote switches.

Table 3: Remote switch connector pin descriptions.

2.7 Connectors – detailed description

Below are descriptions of connectors used to connect to the control panel (cable side).

- Ohmmeter inputs (resistance sensors)
 - plug - molex 39013022
 - pins – molex 39000038
- Voltmeter inputs:
 - 8 pin female Wago 769-108 conductor cross-section: 0.08 ... 4 mm² / 28 ... 12 AWG
- Power input:
 - 3 pin female Wago 769-103 conductor cross-section: 0.08 ... 4 mm² / 28 ... 12 AWG
- SiCAN/NMEA:
 - DeviceNet 5 pin M12 female
- Remote switch:
 - Pluggable terminal block 4 pin female, pitch 5,08 mm, Phoenix Contact 1792265 or similar
- Bilge pump:
 - Pluggable terminal block 4 pin female, Phoenix Contact 1777749
- SiCOM:
 - RJ11 4 pin plug

3 CAN and NMEA ports

3.1 Basic description and connecting

The panel connects to the distribution unit by using a proprietary CAN bus based protocol called SiCAN. This bus uses DeviceNet 5-pin cables and T-splitters. This is the same cable as NMEA2000 drop cable. SiCAN bus is used to connect the panel and distribution unit, which requires at least 1 terminator for short connections (less than 3 meters) or 2 terminators at each end for longer connections (more than 3 meters).

The SiCOM ports on the SPU-303 are inactive and provide no function. They should be left unconnected.

Connecting to the NMEA2000 network is done by using an NMEA2000 drop cable. The NMEA network should also be terminated as per NMEA standard.

The maximum total SiCAN bus cable length is 250 m. It is recommended to keep the bus length as short as possible.

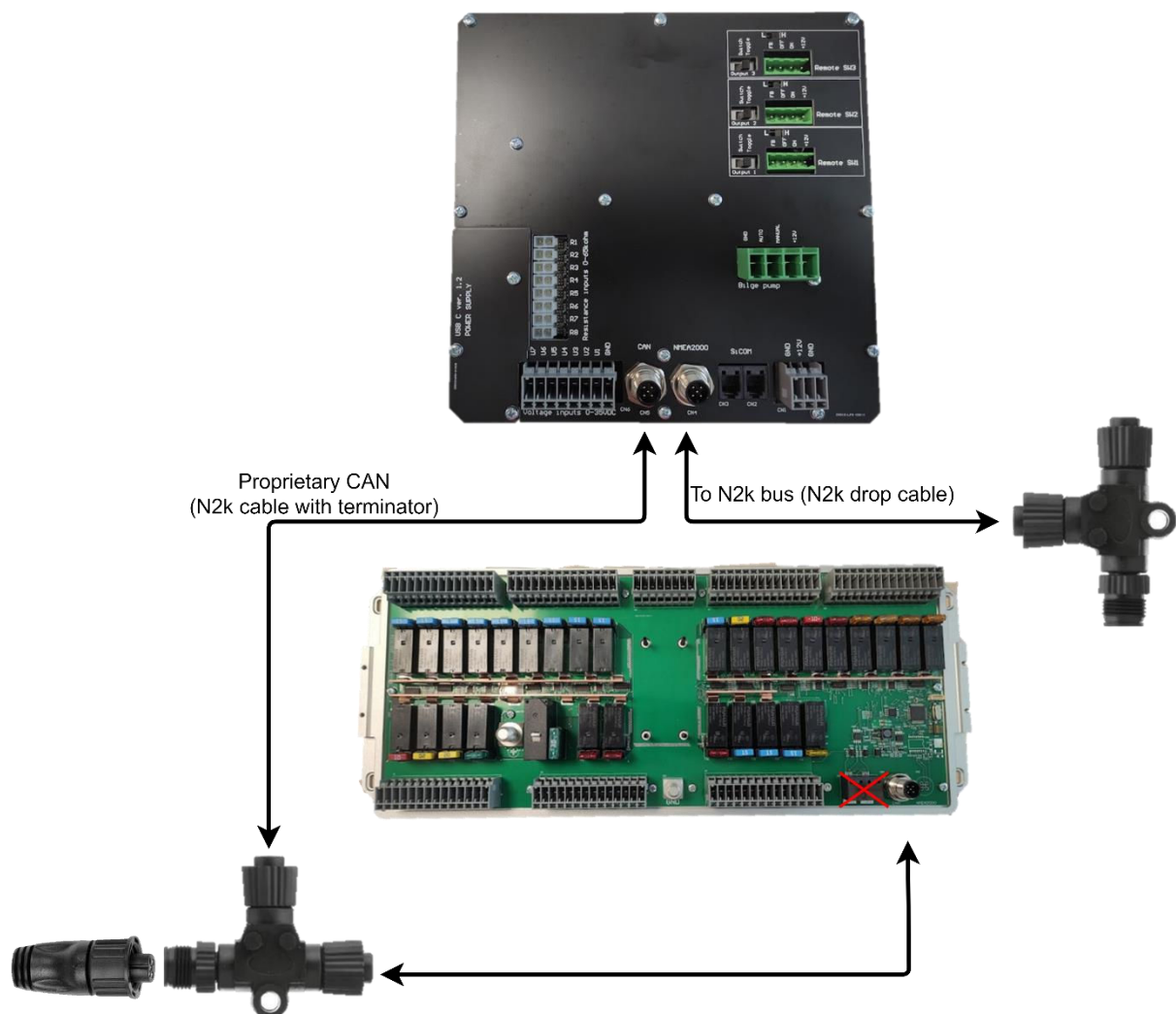

Figure 11: Connecting the panel to the distribution unit and NMEA2000 network.

3.2 NMEA2000 data streaming

The control panel can transmit battery and other data from the integrated PICO to the NMEA2000 network due to the built-in NMEA2000 gateway. This works in the same way, as an SN01

NMEA2000 gateway connected to a standalone PICO. For more information look into the [SN01 user manual \(simarine.net\)](#)

3.3 NMEA2000 remote switching

Note: This function is only available per request when ordering the Nereide 2 system!

In addition to transmitting data from the PICO, the NMEA2000 port allows the control panel to receive switching commands. Other manufacturers MFD's or other devices can be used for remote controlling of the switch states on the control panel.

PGN	PGN Name	Receiving	Transmitting
127501	Binary Switch Bank Status	No	Yes
127502	Switch Bank Control	Yes	No

The buttons on the control panel appear as a single instance of a binary switch bank. By default every button is switchable via the NMEA2000 network. The control panel will periodically transmit PGN Binary Switch Bank Status with the states being the states of the buttons on the front of the control panel. On, off and error states are transmitted.

- The switch control and status indexes are the same and are in the range of 1 to 28.
- The instance of the switch bank for both PGNs is 40 (decimal).
- Indexes 10 and 20 to 28 are unused.
- The "POWER" button is not switchable via NMEA2000.

The visual representation below shows how the indexes are mapped:



















BUTTON INDEX (simarine)	SWITCH INDEX (NMEA2000)	SWITCH INDEX (NMEA2000)	BUTTON INDEX (simarine)
 button 0	switch 1	switch 11	
 button 1	switch 2	switch 12	
 button 2	switch 3	switch 13	
 button 3	switch 4	switch 14	
 button 4	switch 5	switch 15	
 button 5	switch 6	switch 16	
 button 6	switch 7	switch 17	
 button 7	switch 8	switch 18	
 button 8	switch 9	switch 19	
 POWER	/		

Figure 12: NMEA2000 switch bank indexes.

4 DC distribution unit

The DC distribution unit (SPU-303) connects to the battery through the main switch with a recommended 200 A fuse. The unit has 31 switch channels (relays) each connected to 1 or more output pins. Each relay has a corresponding fuse with a rating that must be the same or lower as the maximum allowed current through the relay.

Relay maximum allowed current:

- for relays K1 to K31, excluding K8: max. 20 A
- for relay K8: max 30 A.

General specification:

- Input voltage: 12 V DC (min. 10 V DC, max. 15 V DC)
- Input current continuous: 100 A DC
- Input current maximum: 200 A DC.

Connector type:

- SiCAN/NMEA:
 - DeviceNet 5 pin M12 female
- Power outputs:

1x 8 pin female Wago 769-108	conductor cross-section: 0.08 ... 4 mm ² / 28 ... 12 AWG
7x 14 pin female Wago 769-114	conductor cross-section: 0.08 ... 4 mm ² / 28 ... 12 AWG
- Positive input terminal:
 - M10 threaded bolt nut and washer included
- Negative input terminal:
 - M8 threaded bolt nut and washer included

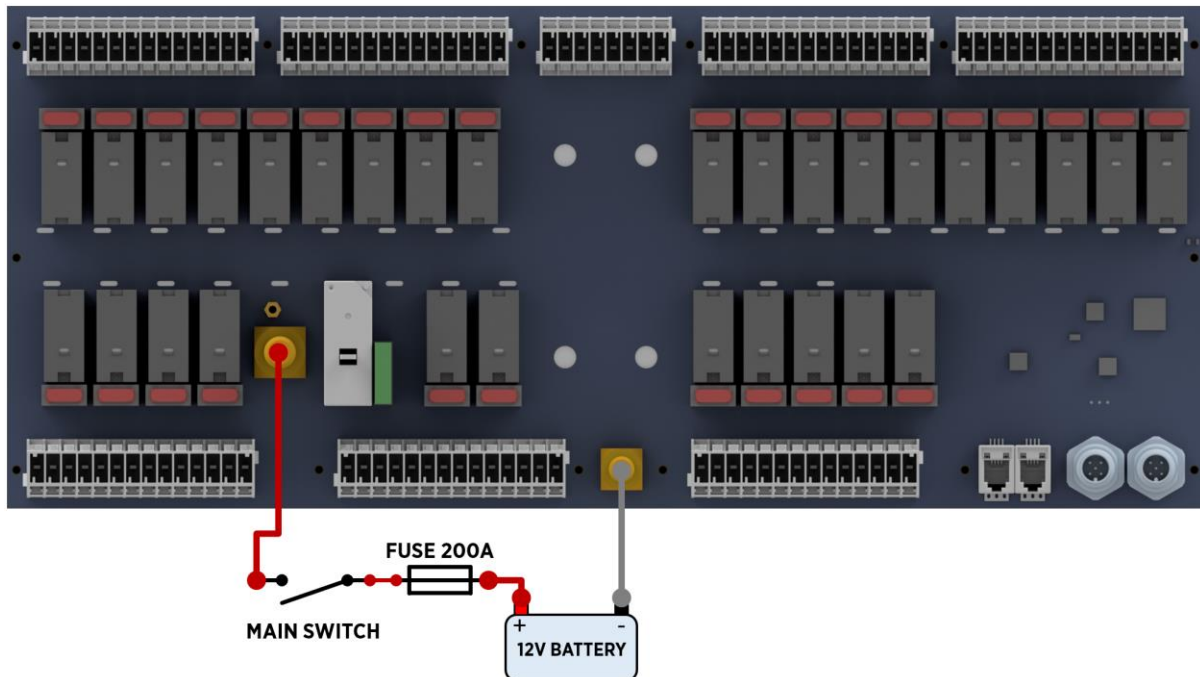

Figure 13: Power source for the DC distribution unit.

4.1 Table of connector pins and corresponding fuses

Below is a table of connectors with associated relays, fuses and output pins.

CONNECTOR	RELAY	FUSE	MAX. CURRENT	12V OUTPUT PINS	FUSE CURRENT RATING - SAILBOAT	FUSE CURRENT RATING - MOTORBOAT
X1	K14	F14	20 A	1.4	10 A	15 A
	K13	F13	20 A	1.3.2	20 A	15 A
				1.3.1		
	K12	F12	20 A	1.2.2	20 A	15 A
				1.2.1		
	K11	F11	20 A	1.1.2	30 A	20 A
				1.1.1		
X2	K8	F8	30 A	2.3.2	30 A	30 A
				2.3.1		
	K9	F9	20 A	2.2.2	10 A	20 A
				2.2.1		
	K10	F10	20 A	2.1.3	10 A	20 A
				2.1.2		
				2.1.1		
	X3	K30	F30	20 A	3.5	10 A
K29		F29	20 A	3.4	15 A	15 A
K28		F28	20 A	3.3	15 A	15 A
K27		F27	20 A	3.2.2	15 A	15 A
				3.2.1		
K31	F31	20 A	3.1.2	20 A	15 A	
			3.1.1			
X4	K1	F1	20 A	4.1.1	15 A	15 A
				4.1.2		
				4.1.3		
	K2	F2	20 A	4.2	15 A	15 A
	K3	F3	20 A	4.3	15 A	15 A
	K4	F4	20 A	4.4	15 A	15 A
	K5	F5	20 A	4.5	15 A	15 A
X5	K7	F7	20 A	5.1.1	15 A	15 A
				5.1.2		
				5.1.3		
				5.1.4		
	K6	F6	20 A	5.2.1	15 A	15 A
				5.2.2		
				5.2.3		

X6	K16	F16	20 A	6.1	15 A	10 A	
				6.2			
	K15	F15	20 A	6.3.1	15 A	10 A	
				6.3.2			
	X7	K24	F24	20 A	7.1.1	20 A	10 A
					7.1.2		
7.1.3							
K25		F25	20 A	7.2.1	10 A	10 A	
				7.2.2			
				7.2.3			
K26	F26	20 A	7.3	10 A	5 A		
X8	K18	F18	20 A	8.1	10 A	15 A	
				8.2			
	K19	F19	20 A	8.3	5 A	15 A	
				8.4			
	K20	F20	20 A	8.5	5 A	10 A	
				8.6.1			
	K21	F21	20 A	8.6.2	5 A	10 A	
	K22	F22	20 A		5 A	10 A	
K23	F23	20 A		5 A	10 A		

Table 4: DC distribution unit output layout.

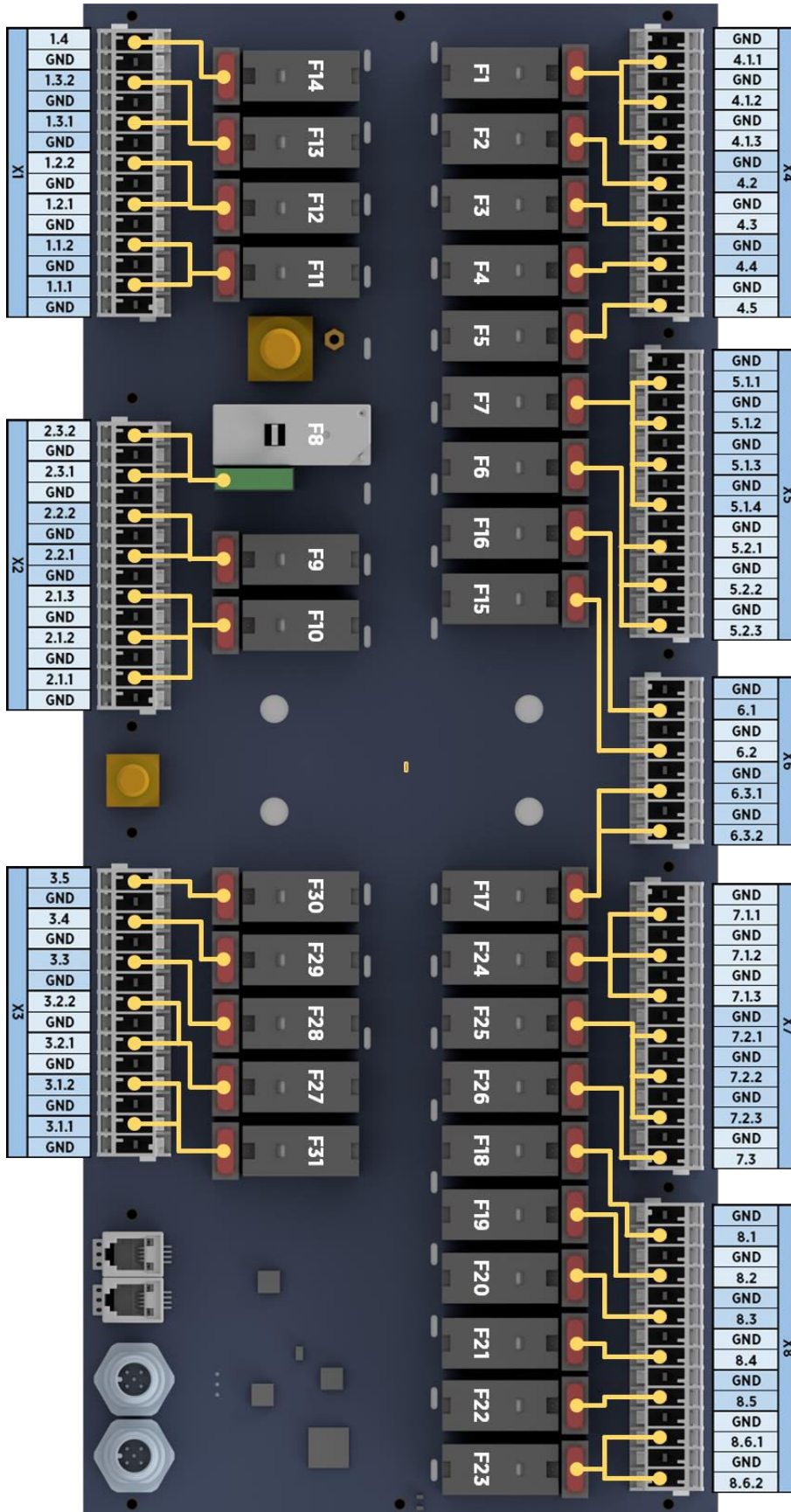

Figure 14: Relays with corresponding pins.

5 Using the control panel and distribution units

The control panel turns on by pressing the power button. To turn the panel off the power button should be held for 1 second. When the panel turns off it first turns off all the relays on the connected DC distribution unit. The panels without bilge pump support turn off immediately and do not enter sleep mode.

The panels with bilge pump support will enter sleep mode when turned off. The LED for the bilge pump will remain active for 24 hours and then the LED will be disabled to achieve even lower power consumption. The control panel still reports the voltmeter and ohmmeter readings to the PICO, but the switching, button functionality stays completely disabled while in sleep mode.





The integrated PICO battery monitor turns off and on simultaneously with the panel. In the panels with bilge pump support, it will also enter sleep mode when turned off. To wake-up the PICO, the panel has to be turned on. All of the monitoring functions of the PICO including alarms will remain active in sleep mode.

To turn on or off a consumer connected to the distribution unit, a short press of a button on the control panel is needed. There are two types of buttons – toggle and momentary. A toggle button will change the set state each time you press it. A momentary button will keep the set state ON as long as you hold it pressed. The button glows in dim white when it is turned OFF and bright blue when it is turned ON.

Each button can control the set state of multiple channels on the distribution unit. Usually 1 button has multiple channels assigned. A channel is a relay and fuse combination on the distribution unit. Each channel is monitored and controlled by the control panel. Each channel has a set state for the relay (ON or OFF), actual state of the relay (ON, OFF, manual ON, manual OFF) and fuse state (OK or BLOWN).

5.1 Button illumination and errors

The buttons can show different colours as feedback for the set state or errors. In case of an error the button will blink between the set state colour and red colour.

	Dim white	Button set to OFF.
	Constant blue	Button set to ON.
	Flashing blue/red.	Error state! Button set to ON, error on assigned channels. Burnt fuse or stuck relay in OFF position on distribution unit.
	Flashing white/red	Error state! Button set to OFF, error on assigned channels. Stuck relay or manually switched to ON position.
	Constant red	Error state! Lost connection to channel. Check CAN connections – loose cables or missing terminators.

5.2 Manual switching of relays on the distribution unit

In case of an error of the relay being in the wrong physical set state, the control panel will periodically command it to switch to the proper set state. While the relays on the distribution unit can be manually switched, if a user switches them while the control panel is still turned on the control panel will command the relay to the set state of the button within a few seconds.

If manual switching of relays directly on the distribution unit is needed, the control panel should be turned off or disconnected from the distribution unit.

Manual switching is used in cases of emergency or in case of the control panel failure.

The figure below shows the positions of the tabs on relays if manual switching is needed.

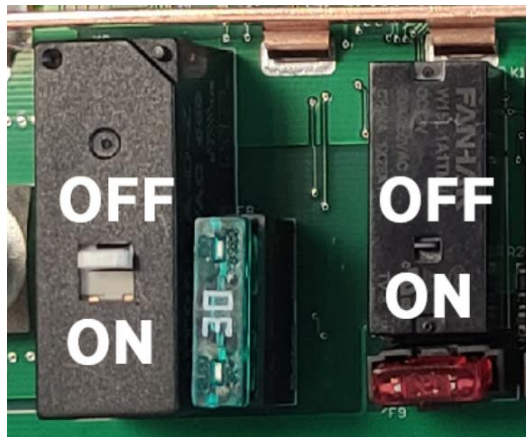

Figure 15: Tabs on relays for manual switching.

6 Predefined configurations

Simarine currently offers 3 predefined button configurations. A configuration is a definition of which button switches which relay on the distribution unit and the label next to the button.

If a customer needs a custom configuration a form to fill out can be requested from sales@simarine.net or support@simarine.net.

Below are the configuration tables for the predefined configurations.

6.1 Sailboat small configuration



















	BUTTON LABEL	RELAY							RELAY					BUTTON LABEL	
	INTERIOR LIGHTING	K1	K6	K7					K2	K3	K4	K5	REFRIGERATOR		
	NAVIGATION ELECTRONICS	K8	K9	K10					K15	K16	K17	K24	FRESH WATER PUMP		
	WINCH	K25	K26								K13	DISCHARGE PUMP			
	MANEUVERING	K14	K18	K19							K12	DECK WASH PUMP			
	NAVIGATION LIGHT	K23									K11	AUX 2			
	TRICOLOR LIGHT	K22									K31	AUX 3			
	STEAMING LIGHT	K21									K27	AUX 4			
	ANCHOR LIGHT	K20									K28	AUX 5			
	AUX 1	K30									K29	AUX 6			

Figure 16: SAILBOAT SMALL

6.2 Sailboat big configuration



















	BUTTON LABEL	RELAY					
	INTERIOR LIGHTING	K1	K6	K7			
	NAVIGATION ELECTRONICS	K8	K9	K10			
	WINCH	K25	K26				
	MANEUVERING	K14	K18	K19			
	NAVIGATION LIGHT	K23					
	TRICOLOR LIGHT	K22					
	STEAMING LIGHT	K21					
	ANCHOR LIGHT	K20					
	BATHING PLATFORM	K30					
	RELAY	BUTTON LABEL					
	K2	K3	K4	K5		REFRIGERATOR	
	K15	K16	K17	K24		FRESH WATER PUMP	
				K13		DISCHARGE PUMP	
				K12		DECK WASH PUMP	
				K11		BILGE PUMP WITH HOSE	
				K31		AUX 1	
				K27		AUX 2	
				K28		AUX 3	
				K29		AUX 4	

Figure 17: SAILBOAT BIG

6.3 Motorboat configuration

















	BUTTON LABEL	RELAY					
	NAVIGATION ELECTRONICS	K24	K25	K26			
		K17	K8				
	INTERIOR LIGHTING	K1	K6	K7			
	FRESH WATER PUMP	K27	K28	K29			
		K30	K31				
	BLACK WATER MAC. PUMP	K9					
	GREY WATER MAC. PUMP	K10					
	DECKWASH PUMP	K11					
	WINCH	K22	K23				
							
							
	RELAY	BUTTON LABEL					
					K15	MANEUVERING	
	K2	K3	K4	K5		REFRIGERATOR	
	K18	K19	K20	K21			
				K16		HYDRAULIC	
				K12		AUX 1	
				K13		AUX 2	
				K14		AUX 3	
						AUX 4	

Figure 18: MOTORBOAT

7 Dimensions and mounting details

All provided dimensions are in mm (millimetres). The decimal point is a comma.

7.1 SCP-210 dimensions

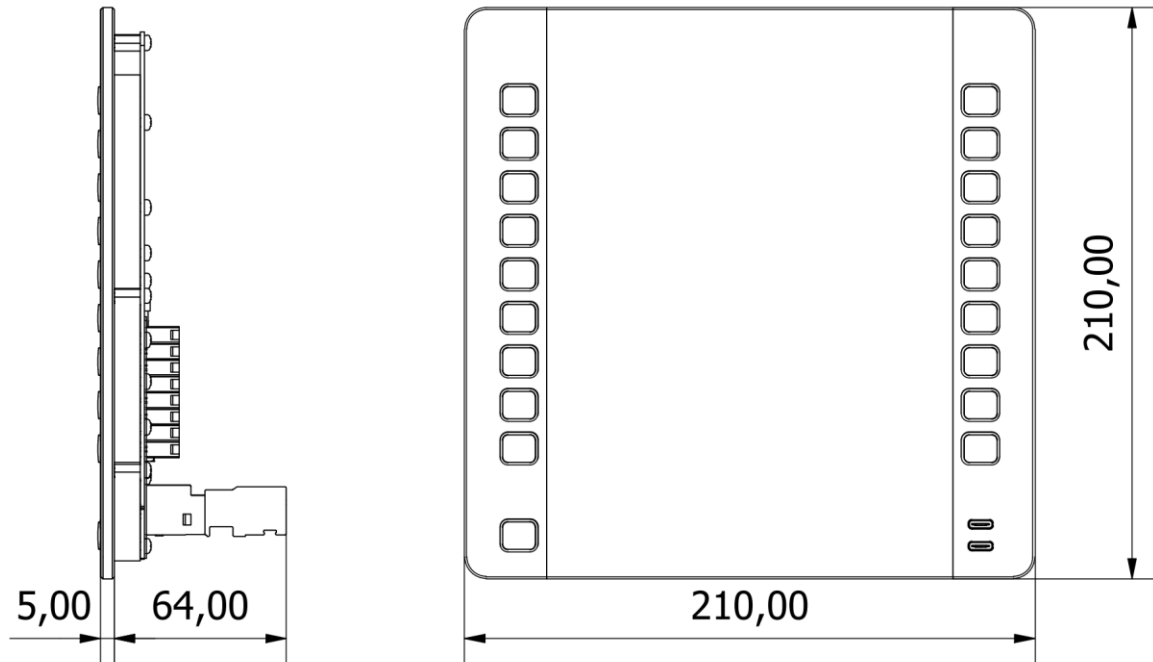

Figure 19: Nereide 2 general dimensions.

When mounting the control panel to the desired surface be aware of the maximum depth of the device with the attached connectors is at least 64 mm. In addition to this depth, there should be an additional 20 mm (minimum 10 mm) distance of space for cables going to the connectors. In short, the minimum distance from the mounting surface to the back of the mounting space is 74 mm.

Bolts for installation are provided with all Nereide 2 control panels (4 pieces M3 bolts with easy-installation knurled nuts).

7.2 SCP-210 cut-out template

198,00

$\phi 3,50$

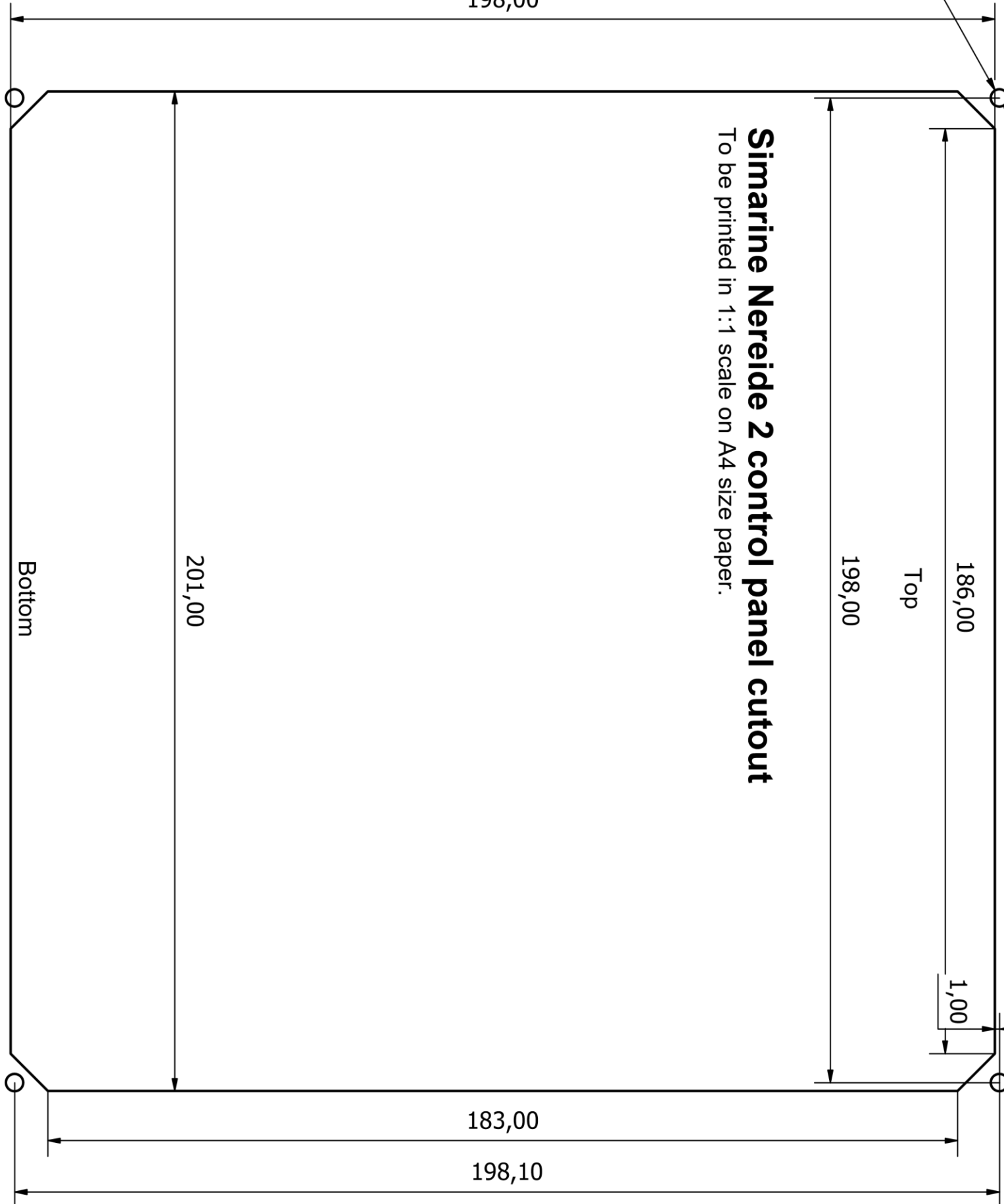

Simarine Nereide 2 control panel cutout
To be printed in 1:1 scale on A4 size paper.

7.3 SPU-303 dimensions

The dimensions for the distribution unit are provided below. Notice the distances for the mounting screws (396,50 mm x 121,00 mm). The installation screws are provided with every SPU-303 distribution unit (4 pieces truss head 3,45x12 mm self-tapping screw).

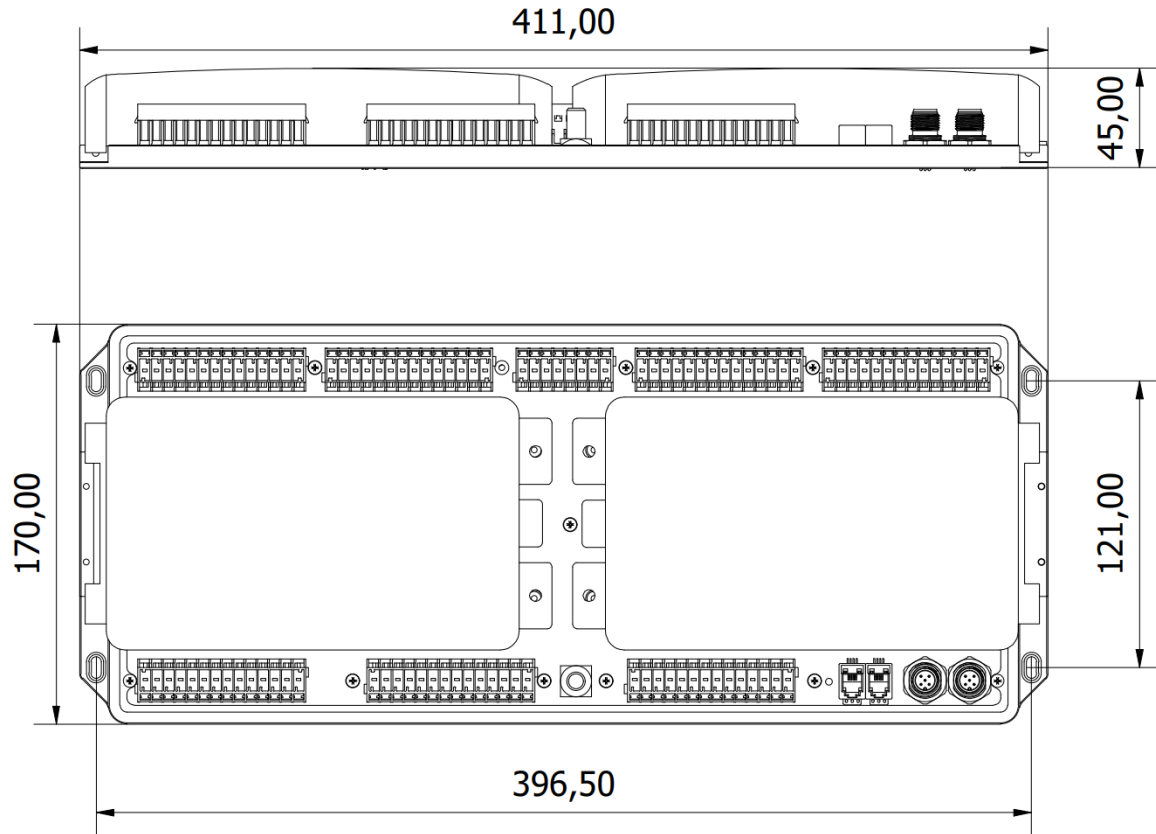

Figure 20: SPU303 DC Distribution Unit general dimensions.

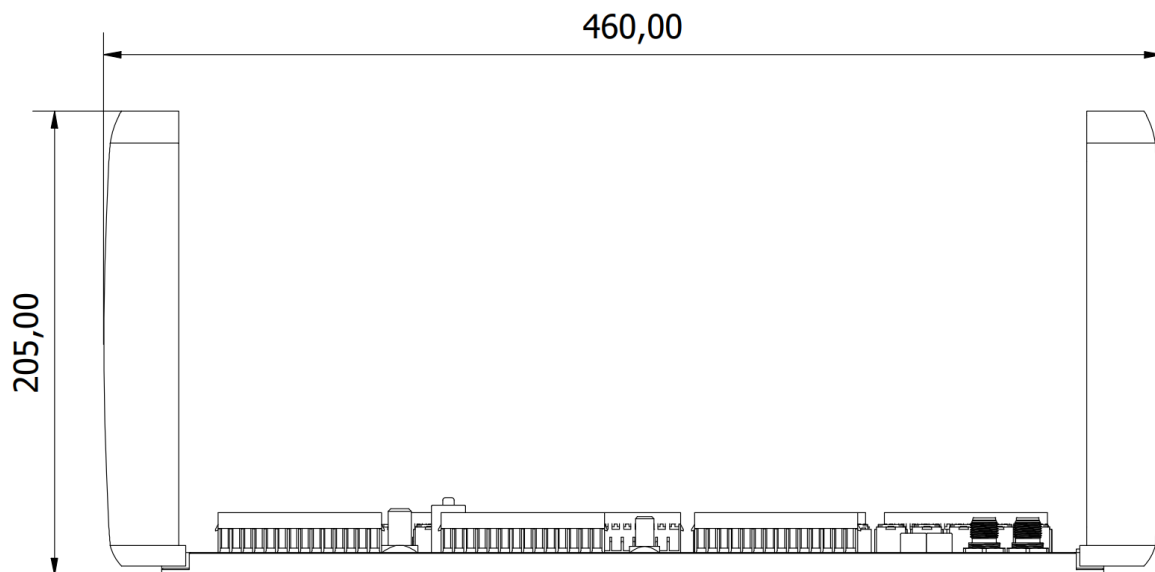

Figure 21: SPU303 dimension with open covers.

8 Change notes

- Document v1.0 – 29th March 2022:
 - Initial version of the document, connection diagrams, basic how to use instructions.

- Document v1.1 – 1st December 2022:
 - Added additional configuration data (key – relay bindings, chapter 6) and DC distribution unit pinout (chapter 4.1).
 - Added ohmmeter and voltmeter specification.
 - Removed bilge pump and remote switch option descriptions, since the feature is not yet in production.
 - Updated fonts and added Simarine logo in header.

- Document v1.2 – 19th December 2022:
 - Added glossary of terminology and changed 1st chapter to “Introduction”.
 - Added NMEA2000 detailed description focused on switching.
 - Added bilge pump and remote switch description of operation.

- Document v1.3 – 31st March 2023:
 - Added a detailed description of power modes.
 - Added current consumption in different modes of operation.
 - Added a list of connectors to be used on connecting cables.

- Document v1.4 – 12th May 2023:
 - Added dimensions of SCP210 and SPU303.
 - Added maximum SiCAN bus cable length.

- Document v1.5 – 14th May 2024:
 - Added SPU-303 connector specification and voltage/current ratings.